

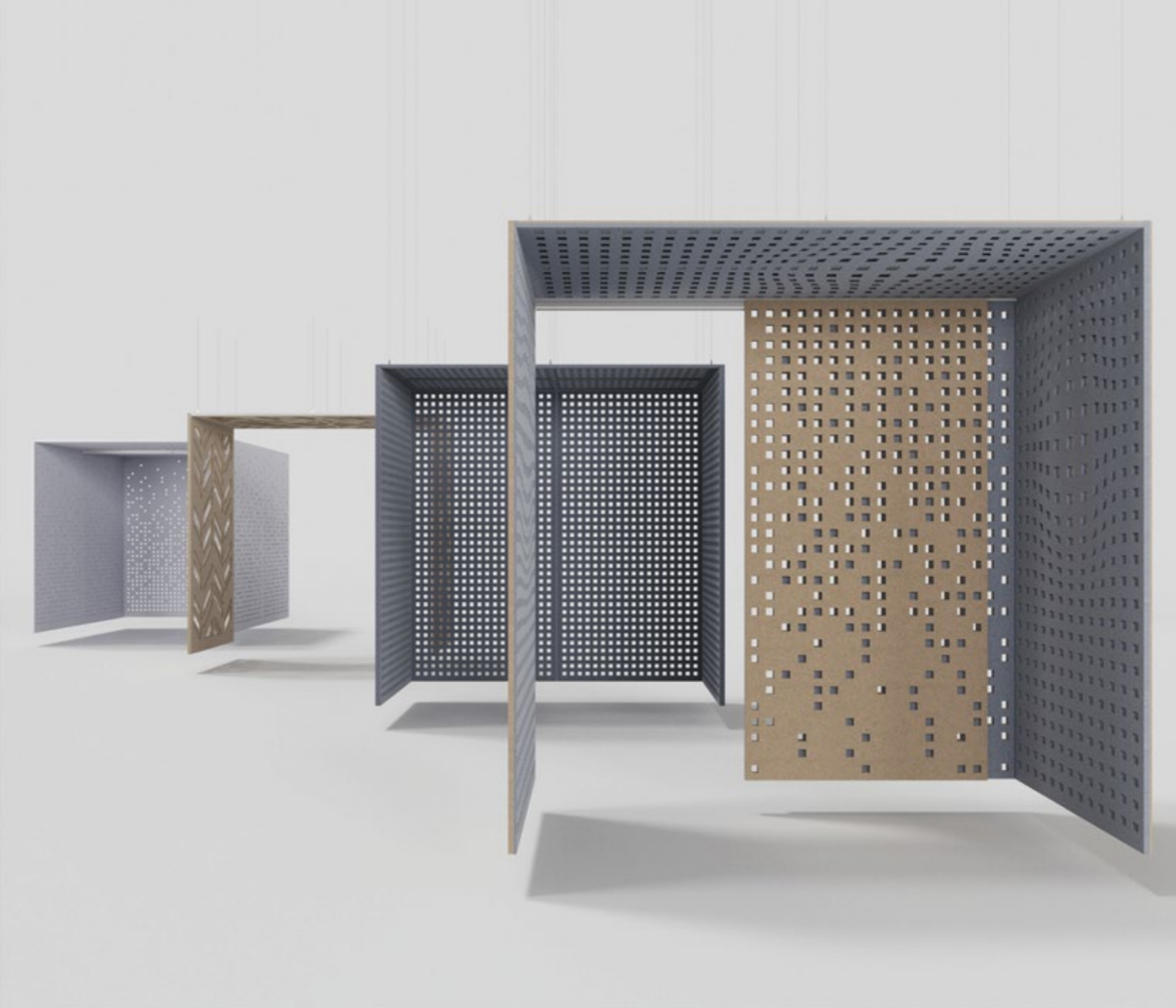

SUSPENDED OFFICE

ezoBord



Meet **SUSPENDED** **OFFICE**

There really is no "one size fits all" solution, privacy encompasses many different needs and behaviors, each form of privacy – acoustical, informational or visual, helps people to feel free, to share ideas and to make work visible.

Designed in collaboration with **B2Lab**, Suspended Office is an ecosystem of spaces that re-define the privacy of the work area and shape collaborative work.

Featuring Ezobord acoustical surface materials in a variety of visually interesting patterns, colors, and configurations that perfectly balance design and functionality.



Shaping Privacy



Suspended Office as a Connection Hub

Configuration Options

Suspended Office is a flexible ecosystem with many configurations that encompasses every type of work; Individual, Collaborative or Remote. Its unique design makes Suspended Office the best way to shape your privacy.

Single Module

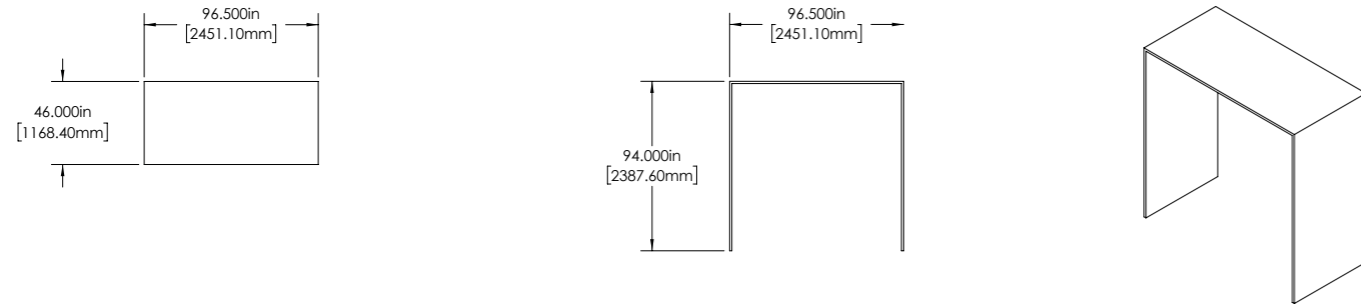

Double Module

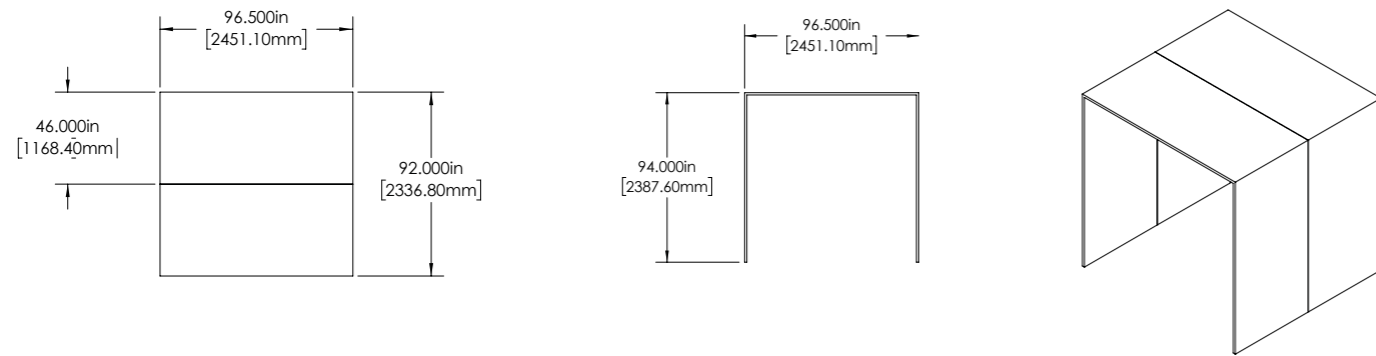

"L" Shape

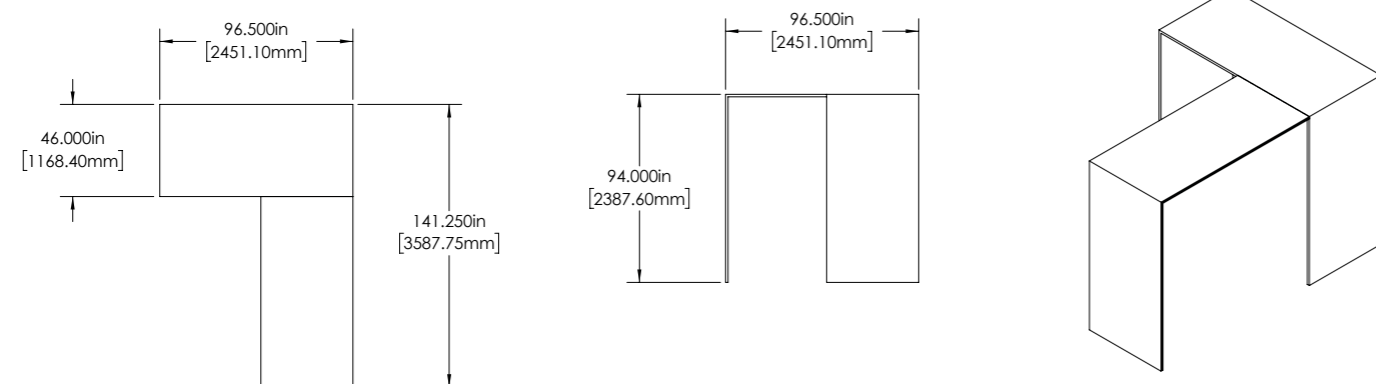

*Design capable of off-modular configurations

Mix & Match Your Colors

12 mm ezoBord material colors could be used for the outer walls of the unit, please refer to the color chart on our website.

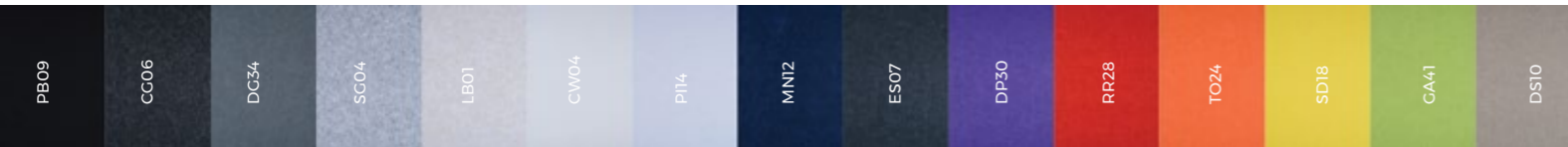

Moss Provided by Quiet Earth Moss™

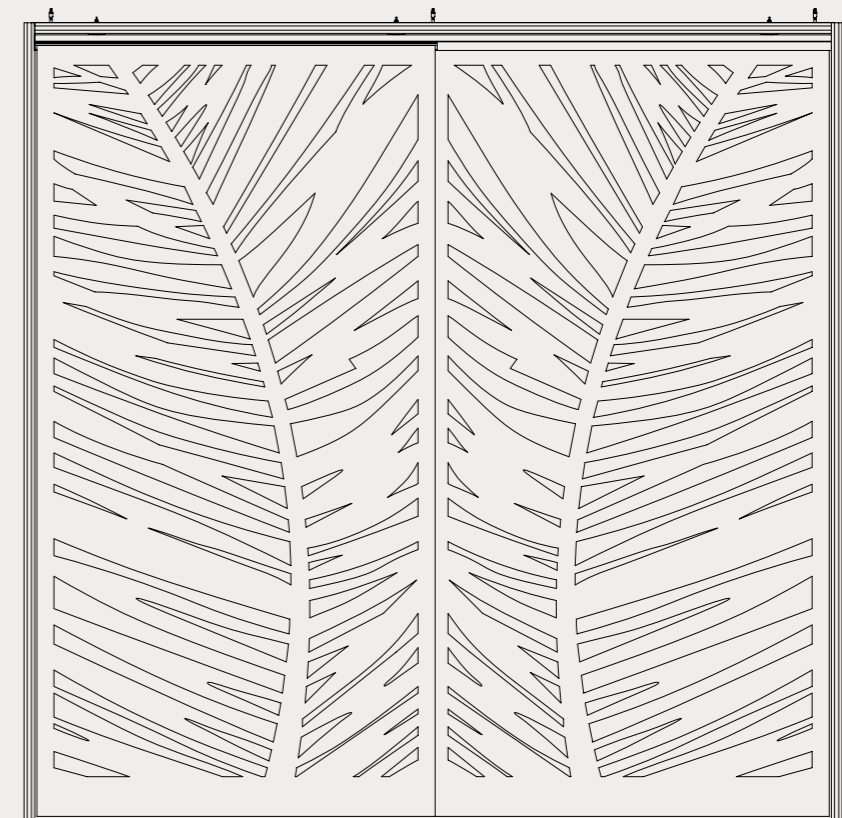

Accessories

Anti-Microbial Treatment:

To be Covid-19 prepared , the unit could be coated with a revolutionary bonded antimicrobial technology for polymers and textiles AEGIS® if requested.

Privacy door:

Single or double doors are available for the units, a counterweight is required when a single door is added to only one side, contact us for more information.

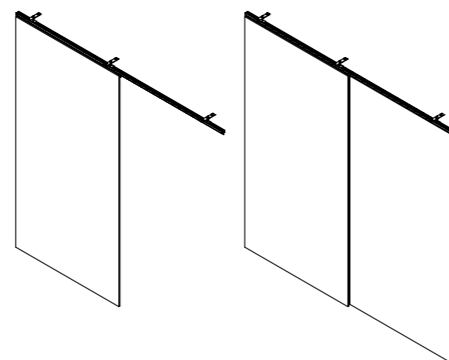

SIZES

Available in four widths and lengths:
 · 94" (2388 mm) Height
 · 96.5" (2451 mm) Length
 · 46" (1168 mm) Width

Multiple configurations available

COLORS

15 standard colors.

THICKNESS

3 layers of 9mm or 12 mm thickness

COMPOSITION

100% Polyester (min 50% +/- recycled PET Fibre.

PRODUCT VARIANCES

Variation in fiber mix and color may occur. All products will be supplied within commercial tolerances.

CLEANING

Remove dust and dirt with a stiff plastic bristle brush. Distilled water can be used to remove stains. Always use a soft, clean cloth and blot dry. Vacuuming works great as well.

INSTALLATION

ezoBord Suspended office will come ready to install with all the required hardware for installation. The installation will typically need two people with basic tools.

ACOUSTICS

NRC.80

USGBC LEED V4 CREDITS

While individual products do not 'earn' LEED credits, ezoBord can contribute to the following LEED v4 Credits. Please refer to the USGBC LEED credit guides for detailed requirements.

- EQc9 for enhancing acoustic performance
- MRc3 BPDO for sourcing of raw materials for recycled contribution
- EQc6 interior lighting for surface reflectance (lighter color options).

Fire Testing

- North America:
 - ASTM E-84 Class A*
 - CAN ULC S102-10
- Europe and UK:
 - EN13501-1: 2007

ENVIRONMENT

Made with recycled polyester fiber, 50% +/- of which comes from recycled water bottles which contributes to LEED MR credit of Recycled content. No VOC's. ezoBord has an approved Environmental Product Declaration with EPD, HPD. No VOC's: CDPH v1.2 and REACH SVHC Compliant. Third Party Health Product Declaration (HPD) and Environmental Product Declaration (EPD) are available. ezoBord is listed in Mindful MATERIALS Library. **This product is ADA Compliant: ADA - ICC A117.1



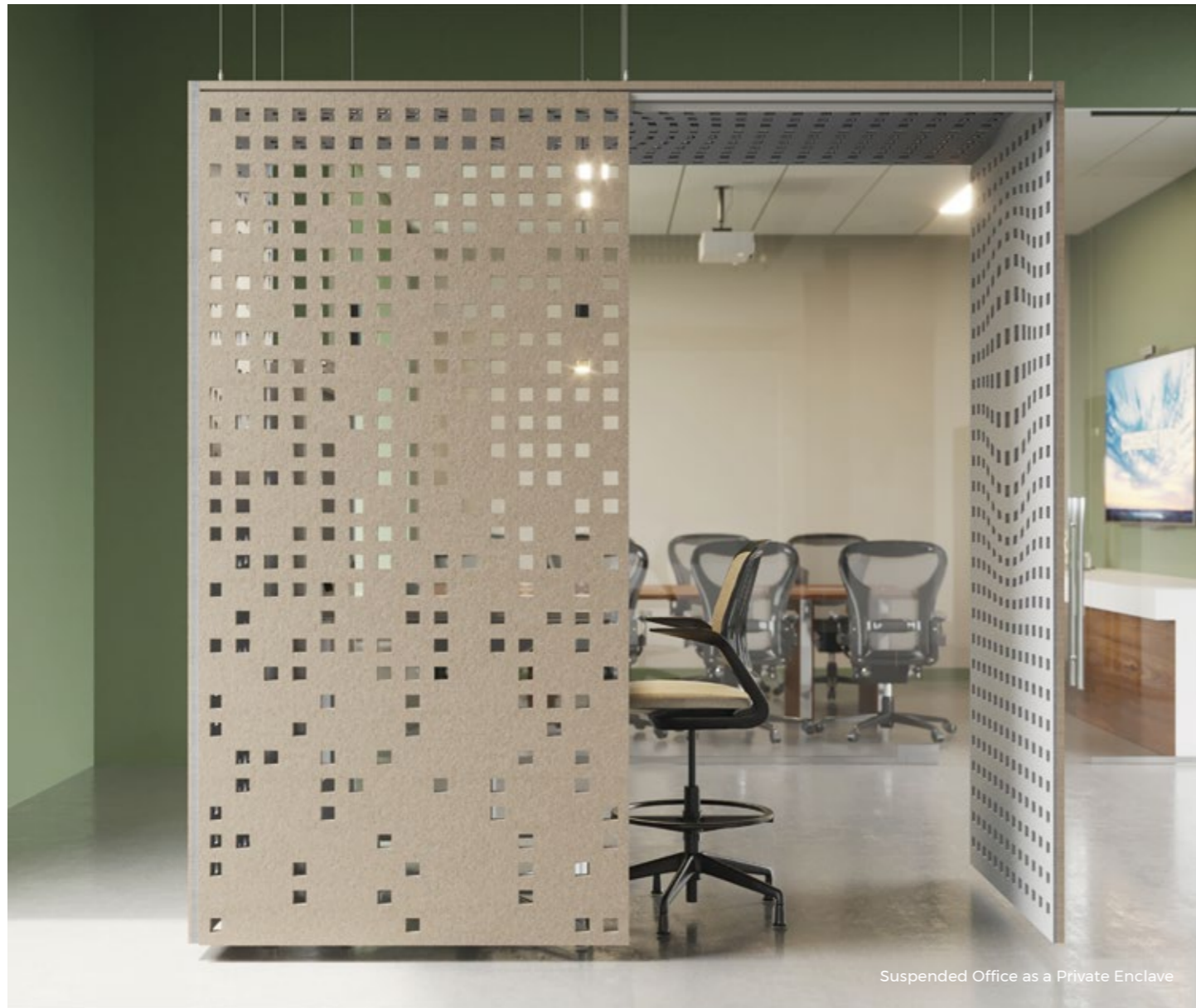

Suspended Office as a Private Enclave



Suspended Office as a Personal Retreat Space

Optional Patterns



Chevron

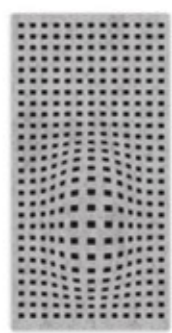

Rectangular Undulation

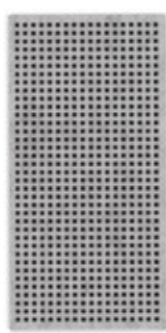

Squares



Pixelated Squares

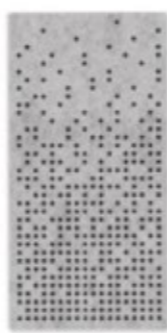

Pixelated Circle

Custom patterns available upon request. / Ceiling patterns may vary./ Walls could be treated as "ezo on ezo" (cut through) or solid. Contact our design team for more information.

ezoBord™



www.ezobord.com